



CE

Special Features

- Stainless steel case & measuring system
- Selectable ranges from
From 0 to 250 mmwc to Max. 6000 mmWC Pressure and Vacuum
- Flanged or screwed connection
- Standard followed in general EN 837 - 3
- C € approved electrical contacts

Application

- Suitable for clean air
- Corrosive environments & Gaseous or non crystallized liquid media that will not obstruct the pressure system.

Specifications

Standard Version : 100 mm & 150 mm

Diaphragm Type	:	0 to 250 mmWC to Max. 6000 mmWC Pressure and Vacuum
Accuracy	:	±1.6% of F. S.
Ambient temperature	:	-25°C to +65°C
Process temperature	:	Max 100°C
Operating pressure range	:	75% of Scale Value
Over pressure limit	:	125% of Scale Value

Case & bezel	:	AISI 304 SS (Bayonet Type)
Top chamber	:	MS Powder Coated
Bottom chamber	:	AISI 316 SS
Movement	:	AISI 304 SS
Diaphragm	:	AISI 316L SS
Gauge connection	:	½" BSP (M)

Protection	:	IP 68
Dial	:	Aluminum, black graduation on white background
Pointer	:	Aluminum, black coloured, micrometer zero adjustable
Window	:	Toughened Glass
Blow off Disc	:	Neoprene
Gasket	:	Neoprene

Electrical contact - dry version

Accuracy	:	±2.5% of F.S.
Ambient Temperature	:	Maximum 65°C
Process Temperature	:	Maximum 65°C
Window	:	Polycarbonate Dome
Electrical Contacts*	:	Refer how to order
Other Features	:	Refer specification of standard version

* Please specify contact set points while ordering.

Temperature effect :

The variation of indication caused by effects of temperature is to be calculated by below formula; which is to be added in the specified accuracy while measurement :- Formula : $\pm 0.08 \times (t_2 - t_1) \%$ of F. S. where t_1 = reference temperature (+20°C) and t_2 = ambient temperature in °C.

Note : The addition of mechanical electric contacts affects the accuracy of instruments such that 1% becomes 1.5%, 1.6% becomes 2.4% etc. (Add the 50% of accuracy; If the contact is of the magnetically assisted type, this value can't be added within the ±5% of setting point.)

Dimensions - standard version

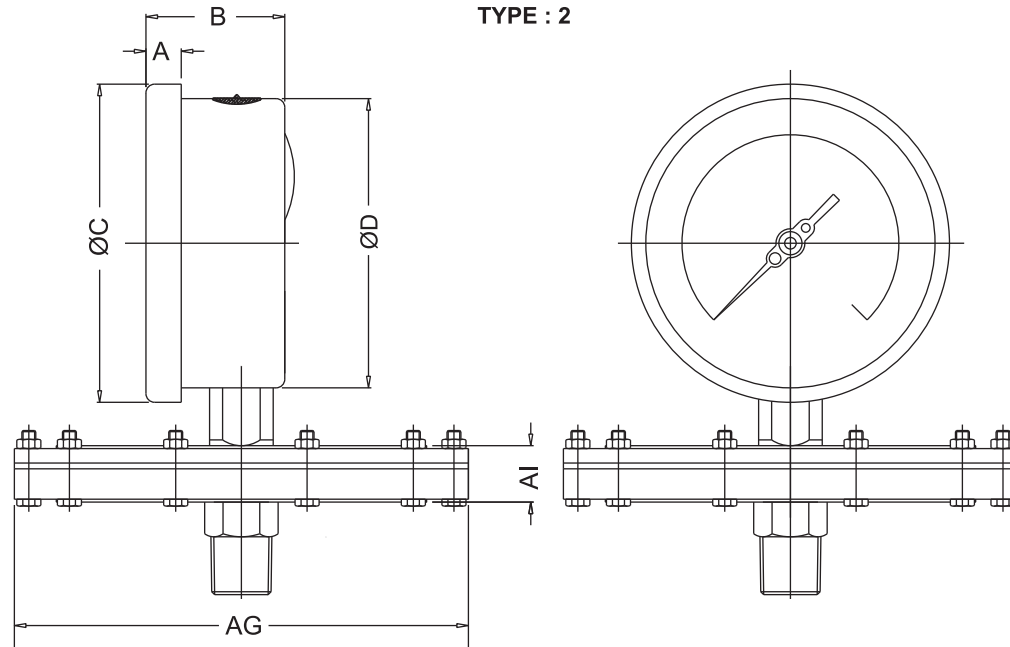

NS	A	B	ØC	ØD	AG*	AI	Weight in gram (With Box)
100	12.5	48	111	100	155	16	2600
150	15.5	48	161	149	155	16	3080

Notes : • Drawings are not to scale.
• All Dimensions are in mm.
• NS = Nominal Size.

Range Table

Note : We offer National / International Scales like kPa, MPa, bar, psi, kg/cm² & Dual Scale like kPa with psi, kPa with bar, bar with psi or Equivalent scales as per the requirement can be provided on request. Following are the example tables for kg/cm² & psi scales

Pressure, Vacuum & Compound Ranges (LP)						
Pressure range			Vacuum & Compound Range			
Single scale - mmWC (LP)			Single scale - mmWC (Vacuum)			
0/250	0/1000	0/2500	- 250/0	- 1000/0	- 2500/0	
0/400	0/1600	0/4000	- 400/0	- 1600/0	- 4000/0	
0/600	0/2000	0/6000	- 600/0	- 2000/0	- 6000/0	
Vacuum & Compound Range			Accessories (refer datasheet for complete specifications)			
Single scale - mmWC (Compound)			GC Gauge cock	SI Siphon		
- 100/150	- 400/600	- 1000/1500	* Needle valve	CT Cooling tower		
- 150/250	- 600/1000	- 1500/2500	SN Snubber			
- 200/400	- 800/1200	- 2000/4000	* Refer catalogue for valves and manifolds			

Range Table

Wiring diagrams for electric contacts

Single Contact

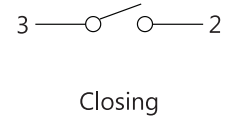
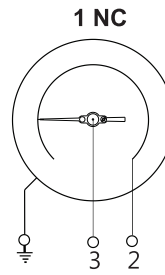
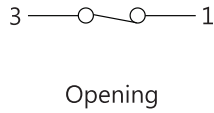
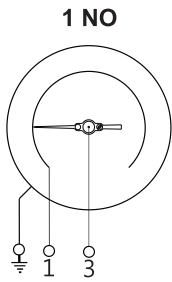

Double contact

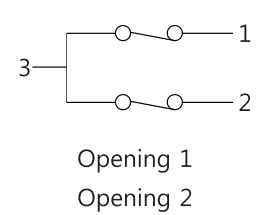
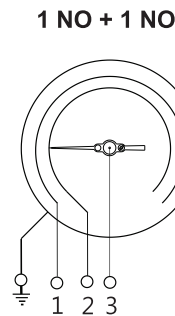
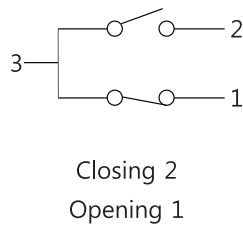
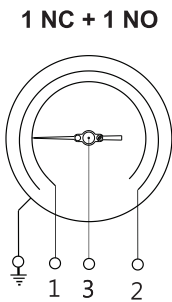
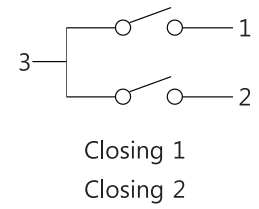
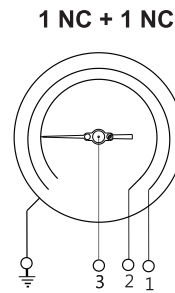
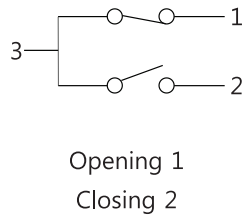
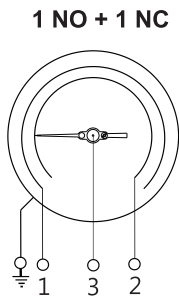

Flange Table

Flange table with ordering codes,

E.g. For flange size of 1" as per BS-10 table E with raised face : B97 - A2 (A2 Raised face A3 Flat face)

As per DIN 2527

DN	PN	CODE
10	6	A01
	10	A02
	16	A03
	25	A04
	40	A05
	64	A06
	100	A07
	160	A08
	250	A09
	400	A10
15	6	A11
	10	A12
	16	A13
	25	A14
	40	A15
	64	A16
	100	A17
	160	A18
	250	A19
	400	A20
20	6	A21
	10	A22
	16	A23
	25	A24
	40	A25
25	6	A26
	10	A27
	16	A28
	25	A29
	40	A30
	64	A31
	100	A32
160	A33	
250	A34	
400	A35	
32	6	A36
	10	A37
	16	A38
	25	A39
	40	A40
	64	A43
40	6	A41
	10	A42
	16	A43
	25	A44
	40	A45
	64	A46
	100	A47
160	A48	
250	A49	
400	A50	
50	6	A51
	10	A52
	16	A53
	25	A54
	40	A55
	64	A56
	100	A57
	160	A58
250	A59	
400	A60	

DN	PN	CODE
65	6	A61
	10	A62
	16	A63
	25	A64
	40	A65
	64	A66
	100	A67
	160	A68
	250	A69
	400	A70
80	6	A71
	10	A72
	16	A73
	25	A74
	40	A75
	64	A76
	100	A77
	160	A78
	250	A79
	400	A80

As per JIS - B 2210

NOMINAL SIZE	RATING /CLASS	CODE
10A	5K	B57
	10K	B58
	40K	B59
15A	5K	B60
	10K	B61
	40K	B62
20A	5K	B63
	10K	B64
	40K	B65
25A	5K	B66
	10K	B67
	40K	B68
32A	5K	B69
	10K	B70
	40K	B71
40A	5K	B72
	10K	B73
	40K	B74

As per DIN 2642

DN	PN	CODE
10	10	A90
15		A91
20		A92
25		A93
32		A94
40		A95
50		A96
65		A97
80		A98

As per DIN 2633

DN	PN	CODE
10	16	A81
15		A82
20		A83
25		A84
32		A85
40		A86
50		A87
65		A88
80		A89

As per DIN 2635

DN	PN	CODE
10	40	A99
15		B01
20		B02
25		B03
32		B04
40		B05
50		B06
65		B07
80		B08

NOMINAL SIZE	RATING /CLASS	CODE
50A	5K	B75
	10K	B76
	40K	B77
65A	5K	B78
	10K	B79
	40K	B80
80A	5K	B81
	10K	B82
	40K	B83

As per ANSI B 16.5

NOMINAL SIZE	RATING /CLASS	CODE
1/2"	150	B09
	300	B10
	600	B11
	900	B12
	1500	B13
	2500	B14
3/4"	150	B15
	300	B16
	600	B17
	900	B18
	1500	B19
2500	B20	
1"	150	B21
	300	B22
	600	B23
	900	B24
	1500	B25
	2500	B26
1 1/4"	150	B27
	300	B28
	600	B29
	900	B30
	1500	B31
	2500	B32
1 1/2"	150	B33
	300	B34
	600	B35
	900	B36
	1500	B37
	2500	B38
	150	B39
	300	B40
2"	600	B41
	900	B42
	1500	B43
	2500	B44
	2 1/2"	150
300		B46
600		B47
900		B48
1500		B49
2500		B50
3"	150	B51
	300	B52
	600	B53
	900	B54
	1500	B55
	2500	B56

As per BS - 10

NOMINAL SIZE	TABLE	CODE
1/2"	D	B84
	E	B85
	F	B86
	H	B87
	J	B88
	K	B89
3/4"	D	B90
	E	B91
	F	B92
	H	B93
	J	B94
K	B95	
1"	D	B96
	E	B97
	F	B98
	H	B99
	J	C01
	K	C02
1 1/4"	D	C03
	E	C04
	F	C05
	H	C06
	J	C07
	K	C08
1 1/2"	D	C09
	E	C10
	F	C11
	H	C12
	J	C13
	K	C14
	D	C15
	E	C16
	F	C17
	H	C18
J	C19	
K	C20	
2"	D	C21
	E	C22
	F	C23
	H	C24
	J	C25
	K	C26
3"	D	C27
	E	C28
	F	C29
	H	C30
	J	C31
	K	C32

Note : 1 Flanged Connections as per BS / ANSI / DIN etc standards with or without Teflonprotection can be provided on request.
2 Flange Finish shall be 125 - 250 AARH as a standard. For other finish, please consult factory.

How To Order						Example																																		
Basic Model						LPD																																		
Code																																								
Nominal Size			40	60																																				
			100 mm	150 mm		XX																																		
Type of Mounting																																								
2	Direct bottom entry		6	2" pipe / yoke mounting with bottom entry*		X																																		
* MOC of bracket and 'U' clamp will be steel. Ask factory for drawings, if required.																																								
Top Chamber																																								
MS	MS Powder Coated (Standard)		S6	AISI 316 SS		XX																																		
Diaphragm																																								
S6	AISI 316L SS (Standard)					XX																																		
Bottom Chamber (* Refer Pressure v/s Temperature table below.)																																								
S4	AISI 304 SS					XX																																		
SL	AISI 316L SS																																							
S6	AISI 316 SS (Standard)																																							
PC	PVC*																																							
PZ	PVDF*																																							
PP	Polypropelene*																																							
<table border="1"> <thead> <tr> <th rowspan="2">MOC of Bottom Chamber</th> <th colspan="6">Pressure V/S Temperature</th> </tr> <tr> <th>20 °C</th> <th>40 °C</th> <th>60 °C</th> <th>80 °C</th> <th>100 °C</th> <th>120 °C</th> </tr> </thead> <tbody> <tr> <td>PVDF</td> <td>10 kg/cm²</td> <td>10 kg/cm²</td> <td>10 kg/cm²</td> <td>7 kg/cm²</td> <td>4 kg/cm²</td> <td>2 kg/cm²</td> </tr> <tr> <td>PP</td> <td>10 kg/cm²</td> <td>10 kg/cm²</td> <td>6 kg/cm²</td> <td>4 kg/cm²</td> <td>1 kg/cm²</td> <td>NA</td> </tr> <tr> <td>PVC</td> <td>10 kg/cm²</td> <td>10 kg/cm²</td> <td>4 kg/cm²</td> <td>1 kg/cm²</td> <td>NA</td> <td>NA</td> </tr> </tbody> </table>						MOC of Bottom Chamber	Pressure V/S Temperature						20 °C	40 °C	60 °C	80 °C	100 °C	120 °C	PVDF	10 kg/cm ²	10 kg/cm ²	10 kg/cm ²	7 kg/cm ²	4 kg/cm ²	2 kg/cm ²	PP	10 kg/cm ²	10 kg/cm ²	6 kg/cm ²	4 kg/cm ²	1 kg/cm ²	NA	PVC	10 kg/cm ²	10 kg/cm ²	4 kg/cm ²	1 kg/cm ²	NA	NA	
MOC of Bottom Chamber	Pressure V/S Temperature																																							
	20 °C	40 °C	60 °C	80 °C	100 °C	120 °C																																		
PVDF	10 kg/cm ²	10 kg/cm ²	10 kg/cm ²	7 kg/cm ²	4 kg/cm ²	2 kg/cm ²																																		
PP	10 kg/cm ²	10 kg/cm ²	6 kg/cm ²	4 kg/cm ²	1 kg/cm ²	NA																																		
PVC	10 kg/cm ²	10 kg/cm ²	4 kg/cm ²	1 kg/cm ²	NA	NA																																		
Process Connection																																								
4NM	½" NPT (M) (Standard)	4TM	½" BSPT (M)	3BM	3/8" BSP (M) (Except Option PLF)	XXX																																		
4BM	½" BSP (M) (Standard)	4MM	M20 x 1.5 (M)	Flanged*	Refer Flange Table with ordering code on previous page																																			
Note : Connections like Metric/ PT/ PF/ Flaired/ UNF/ G/ R etc. can be provided on request. * ask factory for drawings, if required.																																								
Range																																								
Refer range table						0/250 mmWC																																		
Optional extras																																								
CDD	Custom designed dial			PLF	PTFE lining on flange or screwed connection*	XXX																																		
STG	Shatterproof / safety glass			SPD	Silver protection on diaphragm																																			
TND	Tag No Marking on Dial			PPD	PTFE protection on diaphragm**																																			
STP	SS tag plate			PCD	PTFE coating on diaphragm																																			
TCS	Top chamber in AISI 316 SS			PTG	PTFE gasket upto 200°C																																			
OXS	Oxygen service			MOS	AISI 316 SS movement																																			
PY4	2" pipe/yoke mounting bracket & 'U' clamp (AISI 304 SS)			CBS	AISI 316 SS case & bezel																																			
PYS	2" pipe/yoke mounting bracket & 'U' clamp (AISI 316 SS)			MTC	Material test certificates#																																			
* For screwed connection, bore diameter will be minimum 10 mm. ** Suitable for Pressure Ranges only.																																								
# Material test certificates will be provided for wetted parts only with chemical composition testing. For others, please consult factory.																																								
Electric Contacts (CE Approved)																																								
(For dry version, with ingress protection up to IP 55 & poly carbonate dome as a window)																																								
A) Single insulated magnetic snap action type (230 V AC, 1 Amp.)(48 V DC, 0.5 Amp.) (Available for 1000 mmwc & above)			B) Inductive type (220 V AC, 0.4 Amp.) (Available for 1000 mm WC & above)																																					
M1	Single; normally closed (1 NC)		D1	Single; normally open (1 NO)		XX																																		
M2	Double; normally closed + normally open (1 NC + 1 NO)		D2	Single; normally closed (1 NC)																																				
M3	Single; normally open (1 NO)		D3	Double; normally closed + normally open (1 NC + 1 NO)																																				
M4	Double; normally open + normally closed (1 NO + 1 NC)		D4	Double; normally open (both NO)																																				
M5	Double; normally closed (both NC)		D5	Double; normally closed (both NC)																																				
M6	Double; normally open (both NO)		D6	Double; normally open + normally closed (1 NO + 1 NC)																																				
Note: the scale amplitude will be in between 180° to 270° & window shall be polycarbonate dome.																																								
Ordering Example: LPD - XX - X - XX - XX - XX - XXX . 0/250 mmWC - XX - XXX - XX																																								
For non standard products/optional items, please contact factory for delivery and minimum quantity of order.																																								
Refer Datasheet FR for selection of Flushing Rings.																																								
Note : Specifications and dimensions given in this product catalogue represents the state of engineering at the time of printing. Modifications may take place and materials specified may be replaced by others without prior notice.																																								